

Z-Light 6TX

Product Specifications



Z-Light 6TX

Product Specifications



Product Description

6 milliwatt optical transmitter, maximum optical split is 1x8

Features



6 mW output power in 1RU



over fiber

Primarily used for TV video signals, digital TV signals & data signals transported



1310 ± 20nm wavelength



High performance DFB direct modulated laser, advanced pre-distortion circuit & digital automatic processing techniques



Microprocessor monitoring system automatically ensures excellent performance



47-1003 MHz at levels from 5-20 dBmV (AGC/MGC)



Electronic level setting & adjustments

Functional Schematic

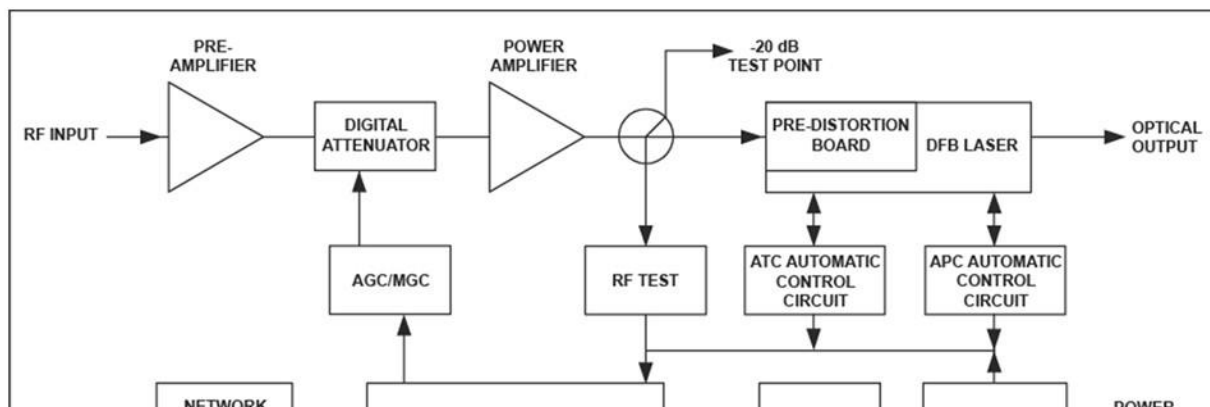

Z-Light 6TX

Product Specifications



Z-Light 6TX

Product Specifications



Part #	ZBT0080147
Optical Information	Modulation Mode: Direct optical intensity modulation Connector Type: SC/APC Power: 6 mW Wavelength: 1310nm +/- 20
Physical Description	Dimensions: 1.75" H x 19.0" W x 15.0" D (44 H x 483 W x 380 D mm) Weight: 11.0 lbs (5.0 kg)
Electrical Power	Power Consumption: 30W Power Voltage: 110-250 VAC (50/60 Hz) (redundant power)
Laser Type	ORTEL DFB laser
Frequency Range	47 to 750 / 862/ 1003 MHz (depending on selected channel load)
RF Input	Level: +12 to +28 dBmV Impedance: 75 Ohm
Flatness in Band	+/- 0.75 dB
Input Return Loss	≥ 16 dB (47 to 550 MHz); ≥ 14 dB (550 to 1003 MHz)
Distortion	C/CSO ≥ 60 dB C/CTB ≥ 65 dB C/N ≥ 51 dB
Control Range	AGC: +/- 5 dB MGC: 0 - 20 dB
Environment	Operating Temperatures: 32°F to 113°F (0°C to 45°C) Store Temperatures: -4°F to 150°F (-20°C to 65°C) Relative Humidity: Max 95% (non-condensing)